

Hurricanes and Severe Storms

Important recommendations from
ACE Recreational Marine Insurance
for protecting your vessel



insured.™

Hurricanes and Severe Storms

Protecting boaters and their vessels, whether they are 20 or 200 feet in length, requires experience, industry knowledge and a degree of creativity. ACE Recreational Marine Insurance has all this and much more. After more than two centuries of insuring yachts and boats of all sizes and types – beginning in 1792 when our predecessor company issued its first marine policy in the United States – ACE stands as the nation’s oldest marine insurance provider, offering our clients unparalleled products, service and stability.

As a leader in promoting maritime safety and as a special courtesy, ACE is pleased to provide you with this exclusive publication on hurricanes and severe storms. We hope you will find it both interesting and informative.

Table of Contents

•General Hurricane Information	3
Severe Weather Terms	3
Saffir/Simpson Scale	3
•General Precautions for Boat Owners	4
Prior to the Hurricane Season	4
Trailerable Boats	4
Non-trailerable Boats in Dry Storage	5
Non-trailerable Boats in Wet Storage	5
Boats Remaining in Marina Berth	5
•Nautical Knots	6
•Specific Precautions for Boat Owners	6
Prior to the Hurricane Season	6
Prior to the Hurricane	8
During the Hurricane	9
After the Hurricane	9
•General Procedures to Process Claims	10
•Summary	11

General Hurricane Information

Hurricane! The word is both feared and respected by knowledgeable mariners along the U.S. coastal areas of the Gulf of Mexico and the Atlantic Ocean. Residents of the Southeast are constantly alert to the news of tropical storms developing in or headed for the Atlantic Ocean, the Caribbean Sea or the Gulf of Mexico. Interest is at its highest during the official hurricane season, which runs from June 1 to November 30.

A hurricane is a violent tropical cyclone, with winds of 74 or more miles per hour, which spirals counter-clockwise around a relatively calm center known as the “eye” of the storm. At full strength, hurricane winds can gust to more than 200 miles per hour as far out as 20 to 30 miles from the eye. Tropical storm winds of 39 mph and greater can extend 200 miles or more in advance of the hurricane and trail hundreds of miles behind. One of the greatest threats from hurricane wind is flying debris. Winds also may disrupt electrical power, telephone service, gas lines, fresh water supplies and transportation. Tornadoes are also possible as a spinoff of the hurricane’s wind.

The greatest danger of the hurricane, however, is from the storm surge. As the storm approaches from the sea and moves across a coastline, a storm surge of water may rise 10 feet or more above normal high tide and usually is accompanied by battering waves that will overcome coastal lowlands. In addition, extensive rainfall associated with the storm may cause widespread flooding further inland. More than 23 inches of rainfall within 24 hours have been recorded in association with a hurricane.

During the hurricane season, the National Hurricane Center (NHC) in Miami maintains a constant watch for tropical disturbances which could develop into destructive storms.

When it appears that a storm is developing, an Air Force reconnaissance aircraft, or one of the National Oceanic & Atmospheric Administration’s (NOAA) research aircraft is sent to the area to make a thorough investigation.

Once a disturbance becomes a depression, the National Hurricane Center will begin issuing advisories. When the depression reaches tropical storm strength, it will be given a name. Advisories then are issued every six hours and indicate the storm’s location, intensity, speed and direction of travel. As a hurricane moves toward the mainland, the NHC may issue advisories more frequently.

Severe Weather Terms in Common Use

- **Advisory** – A message is released by the hurricane center, usually at 6-hour intervals, with updated information on the storm or hurricane, including watches and warnings whenever they are in effect. A *special advisory* is a message given any time there is significant change in weather conditions, or a change in warnings previously issued. An *intermediate advisory* updates information at 2- to 3-hour intervals, whenever a watch or warning is in effect.
- **Hurricane** – A tropical cyclone that rotates counter-clockwise with sustained winds of 74 mph or greater.
- **Hurricane Season** – June 1 through November 30 is officially designated as hurricane season.
- **Hurricane Watch** – The alert given when hurricane/tropical storm conditions pose a threat to a certain coastal area within 48 hours.
- **Hurricane Warning** – Indicates that hurricane/tropical storm conditions are expected to strike within 36 hours with sustained winds of 74 mph or more, accompanied by heavy rain and high waves.
- **Severe Depression** – A circulation at the surface of the water with a sustained wind speed of 38 mph or less.
- **Small Craft Warnings** – When a hurricane or tropical storm threatens a coastal area, small craft are advised to remain in port and not to venture into the open sea.
- **Storm Surge** – A rise in tide caused by a hurricane as it moves over or near the coastline. It can be much higher than the normal tidal rise, with breaking waves on top.
- **Tropical Storm** – A tropical cyclone with sustained winds of 39 to 73 mph.
- **Tropical Storm Warning** – An alert that a tropical storm is expected to strike within 36 hours with sustained winds of 39 to 73 mph.

Saffir-Simpson Hurricane Wind Scale

Hurricanes are classified by wind strength based upon the Saffir-Simpson Hurricane Wind Scale, with Category V storms being the most potentially damaging.

Category	Wind
I	74–95 mph (119–153 kph)
II	96–110 mph (154–177 kph)
III	111–130 mph (178–209 kph)
IV	131–155 mph (210–249 kph)
V	156+ mph (250+ kph)

General Precautions for Boat Owners

Key factors to protecting your boat from hurricanes or any severe weather include planning, preparation and timely action. The following precautions and checklists are meant as guides only. Each boat owner needs a unique plan that takes into consideration the type of boat; the local boating environment; the severe weather conditions likely to occur in that region; and the characteristics of safe havens and/or plans for protection. The following preparations and precautionary suggestions are issued as guidelines to be used by the marine community. While these suggestions may not be applicable to everyone in all instances, it is hoped that common sense and good judgment will prevail. Should even one of these suggestions save a life, prevent an injury or reduce property damage, our purpose will have been served.

Prior to the Hurricane Season

1. Develop a detailed plan of action to secure your vessel in the marina (if permitted), remove your boat from the threatened area or take your boat to a previously identified storm refuge. Specifically identify and assemble needed equipment and supplies. Keep them together and practice your plan to ensure it works before the hurricane season.
2. Arrange for a friend to carry out your plans if you are out of town during the hurricane season.
3. Check your lease or storage rental agreement with the marina or storage area. Know your responsibilities and liabilities as well as those of the marina.
4. Consolidate all records including insurance policies, a recent photo of your vessel, boat registration, equipment inventory, the lease

agreement with the marina or storage area and telephone numbers of appropriate authorities, i.e., Harbor Master, Coast Guard, insurance agent, National Weather Service, etc., and keep them in your possession. You may need these telephone numbers handy when you return to check on your boat after the hurricane.

5. Maintain an inventory of both the items removed and those left on board. Items of value should be marked so that they can be readily identified.
6. Analyze how you will remove valuable equipment from the boat and how long it will take, so you will have an accurate estimate of the time and work involved. When a hurricane is impending, and after you have made anchoring or mooring provisions, remove all movable equipment such as canvas, sails, dinghies, radios, cushions, biminis and roller furling sails. Lash down everything you cannot remove such as tillers, wheels, booms, etc. Make sure the electrical system is cut off, unless you plan to leave the boat in the water, and remove the battery (unless battery is required for bilge pumps) to eliminate the risk of fire or other damage.

In addition to these general steps, which should be taken no matter where you plan to leave your boat during a hurricane or severe weather, there are additional specific steps that should be taken depending on the option you select, as follows.

Trailerable Boats

1. Determine the requirements to load and haul your boat to a safer area. Be sure your tow vehicle is capable of properly and adequately moving the boat. Your trailer tires, bearings and axle all should be in good condition. Too often a flat tire, frozen bearings or a broken axle will prevent an owner from moving a boat.
2. Lash your boat to the trailer once you arrive at a “safe” place, and place blocks between the frame members and the axle inside each wheel. The blocks will prevent damage to the springs from the additional weight of water. Owners of lightweight boats may wish to let about half the air out of the trailer tires, then fill the boat one-third full of water to help hold it down. Consult with the boat and trailer manufacturers prior to performing this procedure.
3. Secure your boat with heavy lines to fixed objects. Try to pick a location that will allow you to secure it from four directions, because hurricane winds rotate and change direction. It can be tied down to screw anchors secured in the ground.



Significant damage can happen to boats whose owners do not take proper precautions.

Non-trailerable Boats in Dry Storage

1. Determine the safest and most realistic haven for your boat, and make arrangements to move it there. When selecting a “safe” location, be sure to consider whether storm surge could rise into the area. Wherever you choose to locate your boat for the duration of the hurricane, lash the boat to its cradle and/or the ground with heavy lines or web straps to ground screws or anchors such as concrete embedded eyes.
2. Never leave a boat in davits or on a hydrolift.

Non-trailerable Boats in Wet Storage

The owner of a large boat, usually one moored in a berth, has three options:

1. Secure the boat in the marina berth.
2. Moor the boat in a previously identified safe area.
3. Haul the boat.

Each action requires a separate strategy. Another alternative – running from the storm – is not encouraged, except for large vessels.

Boats Remaining in Marina Berth

1. Double all lines. Rig crossing spring lines fore and aft. Attach lines high on pilings to allow for tidal rise or surge. Make sure lines will not slip off pilings. Inspect pilings and choose those that seem strongest and tallest, and that are installed properly.

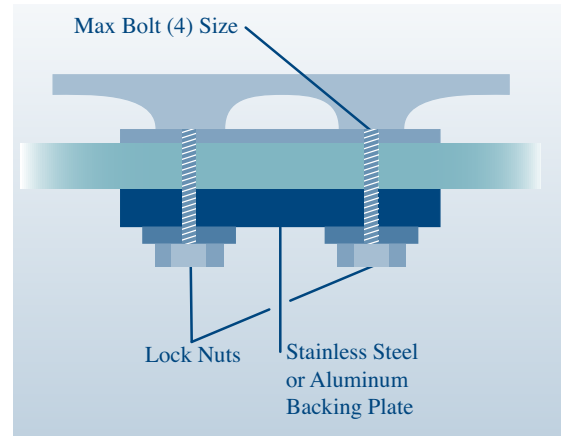

Reinforced and properly backed cleat: note the washers and the backing plate. These are essential in a severe storm, and a good idea in quieter times as well.

2. Cover all lines at rough points to prevent chafing. Wrap with tape, rags and rubber hoses, etc. Install fenders to protect the boat from rubbing against the pier, pilings and other boats.
3. Assess the attachment of primary cleats, winches and chocks. These should have substantial backing plates and adequate stainless steel bolt sizes.
4. Fully charge the batteries and check to ensure their capability to run automatic bilge pumps for the duration of the storm. Consider back-up batteries. Shut off all devices consuming electricity except bilge pumps, and disconnect shore power cables.
5. Do not stay aboard. Winds, during any hurricane, can exceed 100 mph and tornadoes are often associated with these storms. First and foremost, safeguard human life.

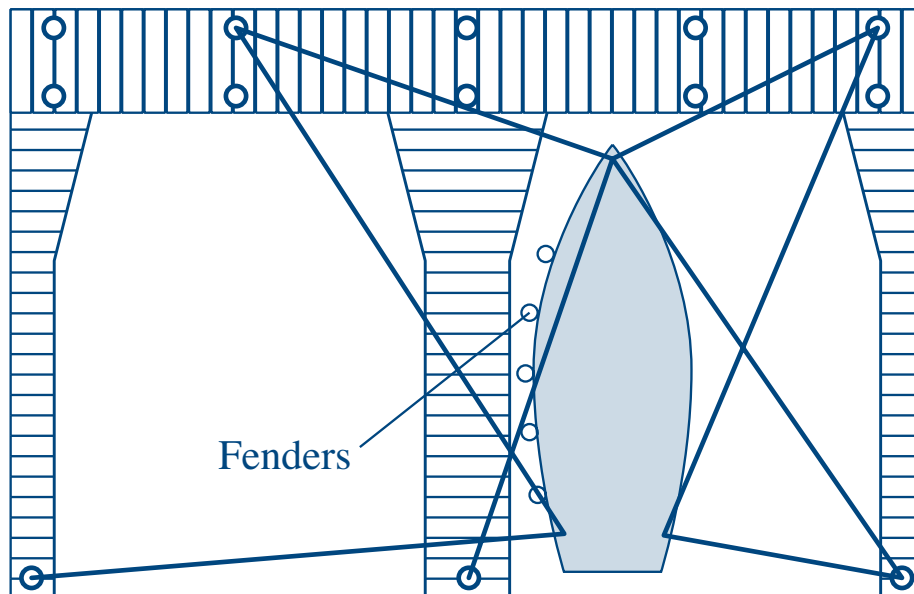

The longer the docklines, the better a boat will be at coping with high tides. It is also essential to double up on all lines and use chafe protectors at any potential chafe points.

Nautical Knots

Figure eight



Square or reef knot



Bowline



Two half hitches

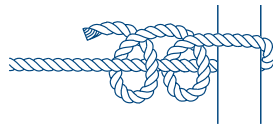

Sheep shank



Specific Precautions for Boat Owners

Marine facilities, marine-related service organizations and insurance companies consider it reasonable to expect a boat owner to take the time and effort to plan for severe weather, and take the necessary actions to secure and protect their vessel. The following recommendations should be considered in formulating an overall hurricane plan for your vessel. Necessary arrangements should be made in advance. If you will be away, a captain or caretaker should be designated to carry out your plan in your absence.

Prior to the Hurricane Season

1. Make sure your vessel is in sound condition. This includes the hull, deck hardware, rigging, ground tackle, machinery and electronics. Absentee owners should arrange for a boat-yard haulout, or a supervised inspection of the vessel prior to, and in preparation for, the
- hurricane season. This includes making sure that batteries are charged, bilge pumps are operable and all equipment is secured.
2. Enhance the watertight integrity of your boat, both above and below the water line. Seal windows, doors and hatches with duct tape, if necessary. Shut sea cocks and cap off or plug unvalved through-hull fittings such as sink drains.
3. Inspect the vessel's deck hardware in light of planned mooring arrangements. Assess the size and structural attachment of the primary chocks, cleats, bitts, bollards and winches. These high-load/high-stress points should have substantial backing plates and be secured with bolts of adequate size.
4. Special attention should be given to avoid chafing of mooring lines. Chafing gear that has been proven successful is a double neoprene hose arrangement.

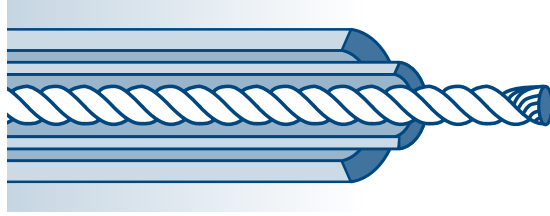

For a super system, if your chocks are large enough, fit a second, larger-diameter hose around another hose that fits snugly to the line. Drill holes in both hoses, and use cord to tie them securely to the line. In a pinch, you can use a single hose.

- Storm moorings, whether at dock or otherwise, should have doubled lines. The second set of lines should be a size larger than the normal lines, including spring lines at a dock.

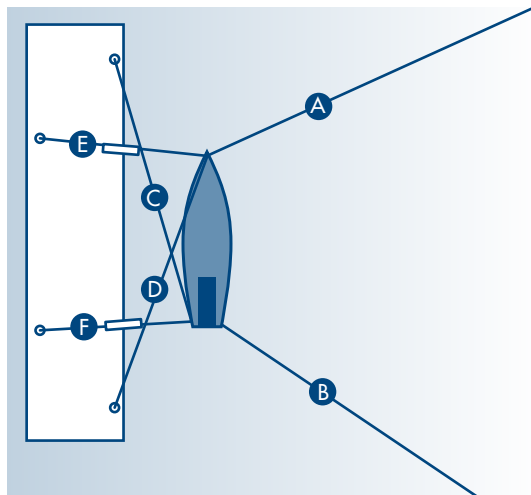

Moorings alongside a dock or bridge:

- Do not allow line to pull sideways on cleat; always lead line along the cleat by use of chocks.
 - Keep the boat off the dock. Do not rely on fenders.
 - Set bow and stern anchors (A&B).
 - Tie bow and stern spring lines (C&D).
 - Make sure lines E&F are long enough and equipped with chafing gear. Possibly run across pier with chafing gear.
- Purchase necessary materials ahead of time such as additional lengths of mooring lines, screw anchors, fenders, fender boards, chafing gear and anchors. These items may not be readily available during the hurricane season, or just prior to a hurricane.
 - If the vessel is to be unattended during the hurricane season, the vessel should be hauled at a storage yard or on its trailer, if trailerable. Making arrangements for wet storage at a protected dock, mooring or marina is another alternative.

- Make up an inventory of all vessel equipment. Note items to be removed from vessel. Keep a copy of the inventory list both on board and ashore.
- For wet berthing locations, ensure that seawalls and docks are sound, mooring bits and cleats are secure and dock pilings and dolphins are in good condition.
- At private berthing and dock facilities in residential areas, check with neighbors and other vessel owners in the area. Coordinate safety and mooring arrangement plans.

Make sure your insurance policy is current.

- At marina facilities, find out their hurricane plans and/or procedures with regard to vessels left at the facility from the dock master or marina management personnel.
- Check with local marine and law enforcement organizations for local plans. This is especially important in coastal areas with barrier islands such as South Florida, where access to inland protected rivers and canals is limited. Bridges may be closed permanently for land evacuation routes when a hurricane warning is issued.
- If your plan calls for moving your vessel from its current berthing location to an inland waterway location, know your route, your vessel navigation requirements at different tides and the restrictions along the route such as bridges (auto and train) and channels. This is especially important for sailboats.

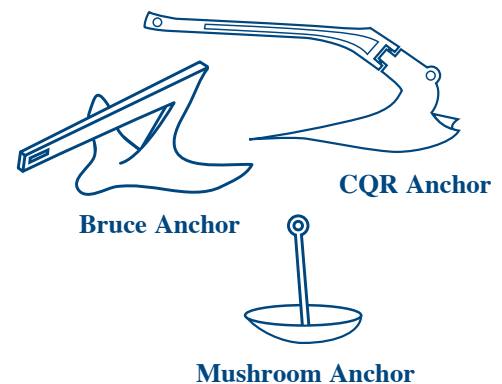

The bruce anchor will bury deeper as the boat pulls harder and hold in a 360° rotation. After surviving the storm, the anchor may be so deep it will have to be sacrificed.

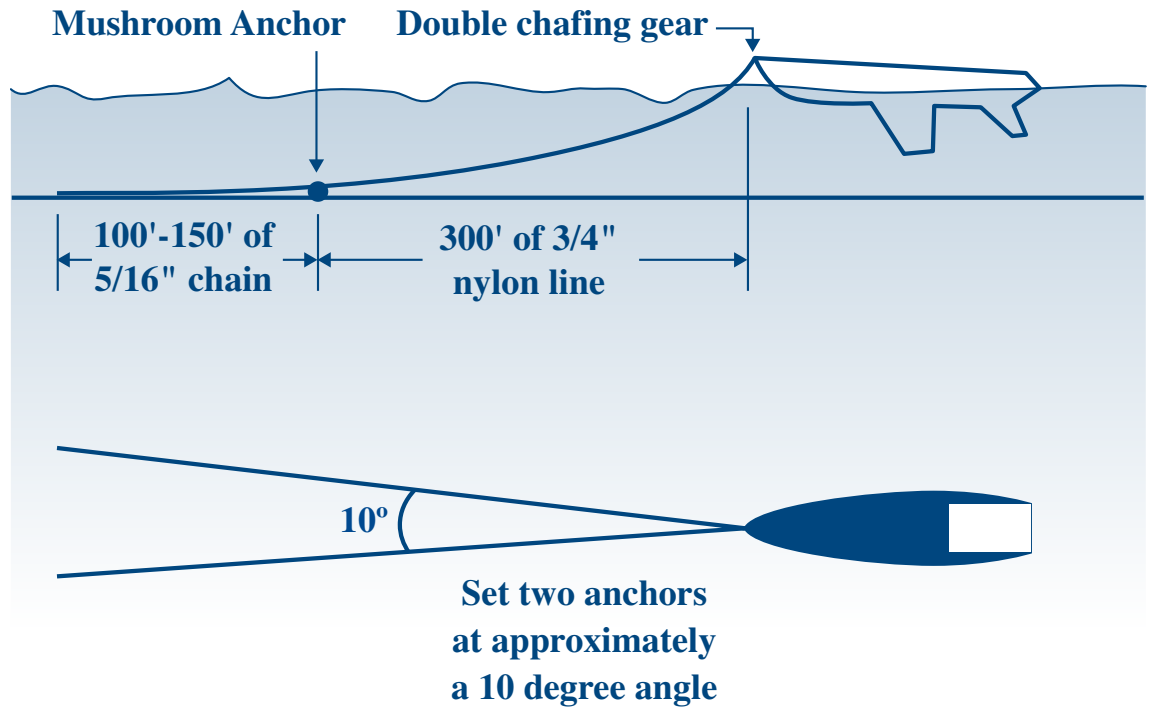

Galveston Bay Anchor System – Set two bruce or CQR anchors on 100' to 150' 5/16" chain and 300 feet of three strand nylon line with a 50–100 pound mushroom anchor shackled on the boat end of the chain, attached to the boat with 3/4" nylon bridle with double chafing gear.

14. Rehearse your planned vessel movement, including an actual visit to the alternate dock or hurricane mooring/anchoring location. If rental of a protected dock or slip is required, make arrangements well ahead of time.
15. Be sure that family or key crew members know your hurricane plan or arrangements, and that everyone who may be involved knows how to contact you or your designated representative or agent.
16. Key your plan on quick response. Moving a vessel, stripping sails, derigging and anchoring in seas resulting from 35 mph winds is extremely difficult and impossible in 45 mph winds.
17. Prepare your hurricane plan in writing and make copies of it. Keep a copy on the vessel and at home. Extra copies also should be made for the marina or yacht club facilities which may require you to have one on file with them. Your insurance company may also request a copy of your plan.
18. Make sure your insurance policy is current. Read the policy thoroughly. There is quite a bit of helpful and advisory information in the policy relative to what the vessel owner should and should not do if there is a storm- or hurricane-related loss or damage to the vessel. Understand the coverages, exclusions and your duties as a vessel owner.

Prior to the Hurricane

1. If your plan calls for moving your vessel, and you have sufficient notice, do it at least 48 to 72 hours (or earlier) before the hurricane is estimated to strike the area. This may be before a hurricane watch is issued.
2. Make sure that:
 - (a) fuel tanks are full;
 - (b) fuel filters are clean;
 - (c) batteries are charged;
 - (d) bilges are clean;
 - (e) seacocks are closed;
 - (f) cockpit drains are free and clear;
 - (g) fire-fighting equipment is in good order;
 - (h) life-saving equipment is in good condition, in place and readily accessible.
These items will be secured later.
3. Remove and/or secure all deck gear, portable gear, radio antennas, outriggers, fighting chairs, deck boxes, bimini tops and side canvas/curtains, sails, boom, dorades, extra halyards, canister rafts and dinghies. Make sure that you secure all hatches, ports, doors, lazarettes and the sailboat rudder. (The dinghy may be required to take lines ashore.)

Correct method of making fast to a cleat

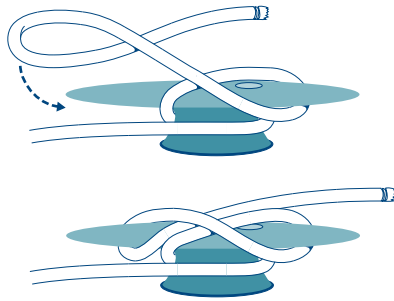

Clove hitch

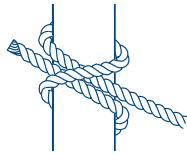

4. If your vessel is moored at a dock on a canal, a river or in a marina near the ocean, it is possible that with an additional 5 to 10 feet or greater storm surge, the vessel could be battered against the dock or even impale itself on the pilings.
5. The best offshore mooring location for a vessel to ride out a storm is in the center of a canal or narrow river where at least doubled mooring lines can be secured to both shores, port and starboard, fore and aft.

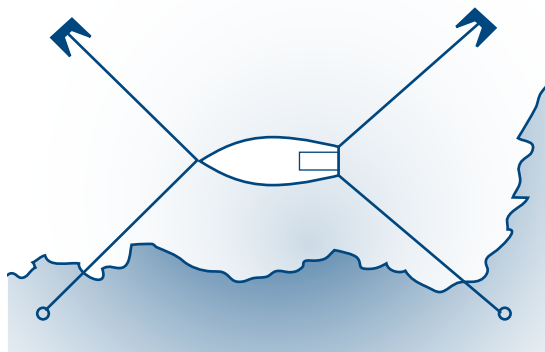

One of many possible arrangements that can be used to secure a boat in a hurricane hole.

6. Do not raft vessels together at moorings or docks, especially if larger and smaller vessels are involved. The probability of damage to the vessels is greater than if they are moored individually.

Using three anchors, set 120° apart, allows the boat to swing and face the wind. This is an especially good technique in crowded harbors because the boat will not swing in as wide an arc as a boat that is riding on only two anchors.

7. If the vessel must remain dockside at a private dock or marina, heavy-duty fender boards (2" x 6") should be used on a bare wood center piling, or otherwise installed to prevent damage. Lines should be doubled and even tripled where necessary to hold a vessel in the center of a berth, or off the seawall or dock pilings. Preventers should be installed at the top of the pilings so lines cannot slip off the top. Note that nylon line will stretch 5 to 10% of its length.

During the Hurricane

1. Do not stay aboard any vessel during a hurricane. If you have taken all the preliminary precautions previously outlined, you have done all that can be done in anticipation of the storm.
2. Stay in a protected and safe place. Attend to the safety of family, home and other personal property.
3. Stay tuned to news broadcasts and weather advisories concerning the hurricane so that you will know when the danger has passed.

After the Hurricane

1. After the hurricane has passed, there may be extensive damage in the area. While checking the condition of your vessel is an important concern, there may be limitations such as flooded roads and downed power lines. A check of the vessel should be made as soon as practical to determine its condition and security.
2. Other vessels may be upriver behind your vessel's mooring location. This may require that you modify your mooring if you are in the center of a canal or stream so other vessels may navigate past you. If you don't, others may just cut your mooring lines and let your vessel drift, causing more damage than the hurricane.

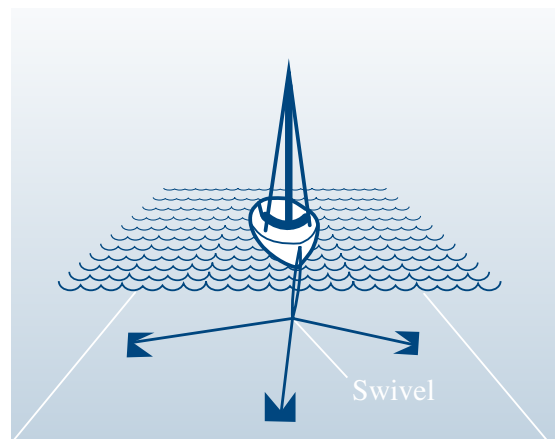

3. A check of vessel security is important if damage has occurred. One security aspect that must be considered is the prevention of looters or others who feel that a damaged vessel is “abandoned” and, thus, theirs to take.
4. If there has been any theft, vandalism loss or damage to the vessel, other than storm-related, a report should be made to local police or other law enforcement authorities so that appropriate actions can be taken. The incident report number and, if possible, a copy of the incident report should be obtained to substantiate any insurance claim or IRS property loss reporting.
5. If damages are incurred to the vessel, immediate action should be taken to save the vessel and/or equipment and prevent further loss or damage. This action is a requirement of all insurance policies. A vessel owner is expected to take those actions that a “prudent, uninsured person” would take to save and preserve his property.
6. If the vessel appears to be unrepairable (constructive total loss), arrangements will still have to be made to remove the hull from any navigable waterway as this will probably be required by government authorities. The vessel should be moved to a yard or salvage facility storage area.

General Procedures to Process Claims

Once you determine you have a loss, the following steps should be taken to process your claim:

1. For the record, photograph the damaged vessel and make a list of all damages and suspected problems. If the vessel is in danger of suffering further loss, take all necessary steps to preserve and prevent further damage. Do not begin repairs other than those necessary to prevent further damage.
2. Promptly call your insurance agent to report the claim or loss. Estimate the type and percentage of damage, i.e., cosmetic, water damage, total loss, etc.
3. Contact repair yards and/or contractors to obtain estimates for repairs. You do not have to wait for an adjuster/surveyor to get estimates.
4. An adjuster, insurance company surveyor or independent surveyor acceptable to the insurance company will be instructed to survey the damages. A boat owner can elect to hire a second surveyor, at his own cost, to conduct an independent survey of the vessel. The boat owner should arrange to accompany the surveyor on the initial damage survey.
5. Have your inventory list, receipts, inventory pictures, photos of damages and repair estimates ready for inspection by the adjuster/surveyor. You will need to provide both a “proof of loss” and “release/payment order.”
6. After conducting the survey, the adjuster/surveyor files a damage report with the insurance company, and sends a copy to the boat owner, if required.
7. The boat owner files a statement of loss with the insurance company explaining what took place, when, where and why. It includes specific lists of known damages along with sketches or drawings.
8. In the event of a dispute, the boat owner may hire a second surveyor/adjuster, at the owner’s expense, to represent the owner’s side of the dispute. A third party will be designated to listen to both sides and arrive at a decision.

**Promptly call your insurance agent
to report the claim or loss.**

9. If the boat owner agrees on the estimates and the company designated to do the repairs, the insurance company issues a check with both the repair firm and owner listed as payees on the check.
10. When the work is completed to the owner's satisfaction and approval, the check is co-signed and the repair firm is paid.
11. Keep in mind that, with all the confusion accompanying the aftermath of a hurricane, the claims adjusters will have many customers to consult with during this time. Having all the appropriate paperwork completed and readily available may help expedite your claims process.
12. If a total loss of a vessel exists, a check is issued by the insurance company to the boat owner – usually for an amount equal to the agreed value, or the fair market value of the vessel.
13. In the event of a total loss, be prepared to surrender the vessel's documentation papers and/or title, original insurance policy, any remaining equipment and the damaged vessel itself.

Remember!

If a vessel is insured and damages have occurred, a report of loss and/or damage should be made to the insurance agent and/or company as soon as possible. A telephone call will suffice to put them on notice. This should be followed up with a written notice. Provide all the details that you can on this first notice, such as:

- (a) exact location of vessel and accessibility;
- (b) structural condition of vessel, and extent of damage (e.g., holes in hull, major or minor damages);
- (c) did the vessel partially sink and is the machinery and/or interior wet?
- (d) must the vessel be removed immediately and if so, to what location?

Be Aware!

Insurance companies will have surveyors and adjusters in the area to assist and work with their policyholders. In locations designated as disaster areas, there may be insurance teams and claims offices established. While surveyors, adjusters, company representatives and many repair facilities will try to work with you, only you have the right and authority to determine what is to be done to or on your vessel. There will be many boat owners with damaged vessels and repair facilities will be very busy. You will need to complete the necessary preliminary work quickly to get your vessel repaired in a timely manner.

Summary

Important Points to Know

- Develop your hurricane weather plan early.
- Make all arrangements for moving and securing your vessel prior to the hurricane season.
- Do not stay on your vessel, or attempt to move or secure your vessel after small craft warnings have been posted. Marine agencies will pull their vessels from the water when wind and seas warrant. They do not risk their lives to rescue careless boaters.
- Stay tuned to all broadcasts and official bulletins until the storm has fully abated.
- Do not return to your vessel until the hurricane has cleared your area and you are told that it's okay to return.
- Do not allow yourself to become a hurricane statistic! Your life is more valuable than your vessel.

For a complete listing of other publications provided by ACE Recreational Marine Insurance, please visit us at:
www.acemarineinsurance.com



**ACE Recreational
Marine Insurance**
436 Walnut Street
WA 11F
Philadelphia, PA
19106

www.acemarineinsurance.com

This brochure contains general information only. The information has been gathered from various sources believed to be reliable, but it is not intended to be a substitute for advice from a safety expert or legal counsel.

Policies issued by ACE American Insurance Co., ACE Fire Underwriters Insurance Co., and Insurance Company of North America – ACE Group companies that are rated A++ (Superior) by A.M. Best Company and AA by Standard & Poor's. Company ratings as of June 1, 2014.